

# Data Sheet



Article number: 021816011379

Description: Clamp with bracket and rubber  
SPGU 6011. 379/30 SK

## Measures

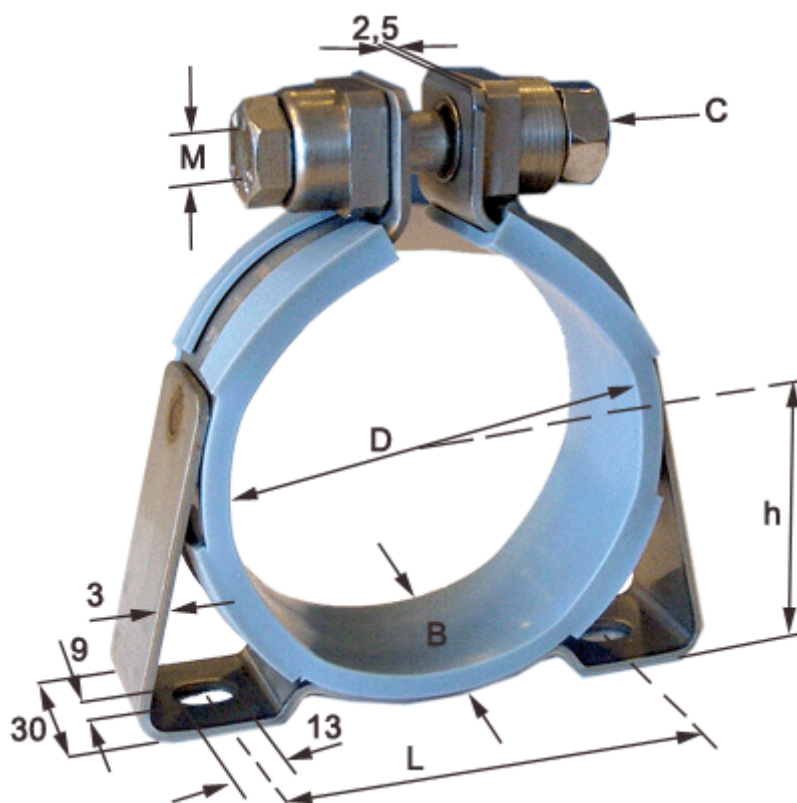

C (screw type) = SK hexagon screw

Diameter D = 379

h = 198

L = 345

Width B = 30